

Relative Permittivity Measurements of 1,1,1,2-Tetrafluoroethane (HFC 134a), Pentafluoroethane (HFC 125), and Difluoromethane (HFC 32)

Andrew P. Abbott,* Christopher A. Eardley, and Richard Tooth

Chemistry Department, Leicester University, Leicester, LE1 7RH, U.K.

The relative permittivity of HFC 134a, HFC 32, and HFC 125 was measured as a function of temperature and pressure, to cover the liquid and gaseous states. The temperature range studied was 303 to 403 K, and the pressure range was 4.0 to 30.0 MPa. The relative permittivity, ϵ , could be fitted to the reduced density ρ_r using the function $(\epsilon - 1)/(2\epsilon + 1)$. The dipole moment of HFC 134a in the liquid phase has been calculated.

Introduction

Hydrofluorocarbons, HFCs, have been extensively studied as replacements for CFCs as they are nontoxic and atmospherically less harmful. HFCs such as 1,1,1,2-tetrafluoroethane (HFC 134a) are now extensively used as refrigerant gases. While the *PVT* characteristics of many HFCs have recently been measured (Outcalt and McLinden, 1995; Tillner-Roth and Baehr, 1994; Tillner-Roth and Yokozeki, 1997), very little is known about their solvent properties. As we have recently shown (Abbott and Eardley, 1998), these fluids are of great interest because of their relatively low critical temperature and pressure and their relatively high polarity in the critical state. To model the solvent properties of these fluids using the mean sphere approximation (Abbott and Eardley, 1998), the relative permittivity must be known. In the current work we have measured the relative permittivity of HFC 134a, difluoromethane (HFC 32), and pentafluoroethane (HFC 125) as a function of temperature and pressure. This work provides the first relative permittivity data available for supercritical HFC 134a, HFC 32, and HFC 125, as well as liquid HFC 125. The critical parameters for these fluids are shown in Table 1 (Outcalt and McLinden, 1995; Tillner-Roth and Baehr, 1994; Tillner-Roth and Yokozeki, 1997), with the dipole moments given for the gaseous HFCs (Meyer and Morrison, 1991).

Experimental Section

Values of the relative permittivity of the solvent were measured using the cell shown in Figure 1. The cell was constructed from 316 stainless steel with an internal volume of approximately 15 cm³. The electrical feedthroughs consisted of microwave cable (RS Components Ltd.) sealed by swagelok fittings. The electrodes were made of nickel, each with an area of 7.5 cm², with a 1 mm gap between the rectangular plates. Prior to experiment the cell was purged with the appropriate HFC gas at reduced pressure. Pressure was then applied using a model 10-600 pump (Hydraulic Engineering Corp., Los Angeles, CA), driven by compressed air. The temperature of the cell was measured using an iron/constantan thermocouple, the tip of which

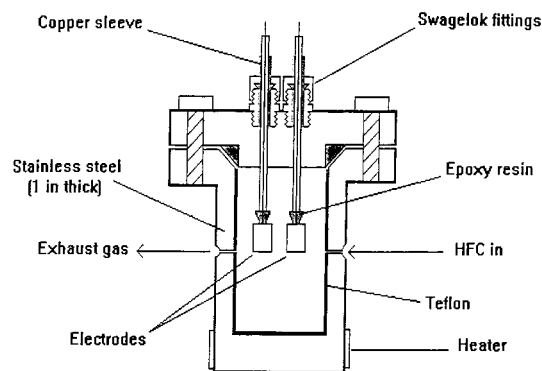

Figure 1. High-pressure capacitance cell.

Table 1. Physical Properties of the Fluids Studied

	HFC 32	HFC134a	HFC 125
T_c /K	351.26	374.21	339.33
P_c /MPa	5.782	4.059	3.629
μ /D	1.978	2.058	1.563
ρ_c /kg·m ⁻³	424.00	511.90	571.30

was in contact with the solvent close to the cell center, and retained at a given value (± 0.5 K) using a CAL 9900 controlled heater. The pressure was monitored (± 0.2 MPa) using a UCC type PGE 1001.600 manometer. The solvents, HFC 134a, HFC 125, and HFC 32 (all ICI Klea group, with a stated purity of 99.99%), were used as received.

The relative permittivity, ϵ , was measured with capacitance C_0 such that the measured capacitance was given by

$$C = \epsilon C_0 \quad (1)$$

Cell capacitances were measured at 65 kHz with a 20 mV ac voltage amplitude using a 1254 frequency response analyzer and a 1286 potentiostat (both Solartron Instruments). The cell geometrical capacitance was 6.6 pF. C_0 was measured prior to each experimental run. The uncertainty of each capacitance measurement was 40 fF. The equipment was tested with several pure solvents of known ϵ , including dichloroethane, toluene, and acetonitrile. In each case the measured ϵ varied from the literature values by no more than 1%. Values of solvent density were taken

* Corresponding author. Fax: +44 116 252 3789. E-mail: apa1@le.ac.uk.

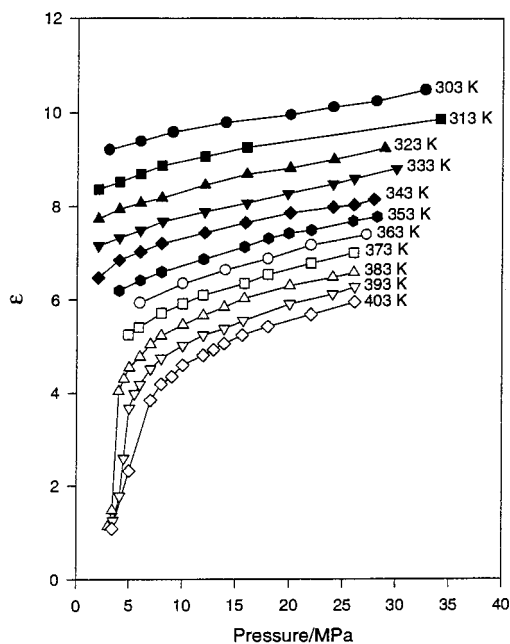

Figure 2. Pressure dependence of the relative permittivity of HFC 134a at various temperatures.

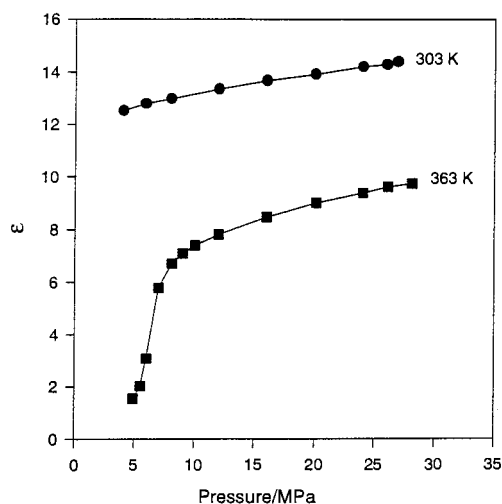

Figure 3. Pressure dependence of the relative permittivity of HFC 32 at various temperatures.

from the literature (Outcalt and McLinden, 1995; Tillner-Roth and Baehr, 1994; Tillner-Roth and Yokozeki, 1997).

Results

Figures 2, 3, and 4 show the relative permittivity of HFC 134a, HFC 32, and HFC 125, respectively, as a function of pressure over a range of temperatures compiled from the data given in Tables 2–16. As stated earlier the uncertainty of each pressure measurement is ± 0.2 MPa. For HFC 134a the uncertainty of each density is no more than ± 2 $\text{kg}\cdot\text{m}^{-3}$ at 303 K, rising to a maximum of ± 16 $\text{kg}\cdot\text{m}^{-3}$ at 403 K. HFC 32 has a density uncertainty maximum of ± 2 $\text{kg}\cdot\text{m}^{-3}$ at 303 K and ± 10 $\text{kg}\cdot\text{m}^{-3}$ at 363 K. For HFC 125 the density uncertainty is no more than ± 3 $\text{kg}\cdot\text{m}^{-3}$ at 303 K and ± 21 $\text{kg}\cdot\text{m}^{-3}$ at 353 K. The relative permittivity values were obtained with an uncertainty of $\pm 1\%$. The HFC 134a ϵ values at 303 K measured here are slightly higher than those previously reported (Barao et al., 1995); however, the difference lies within the experimental uncertainty in ϵ . The relative permittivity, ϵ , increases with

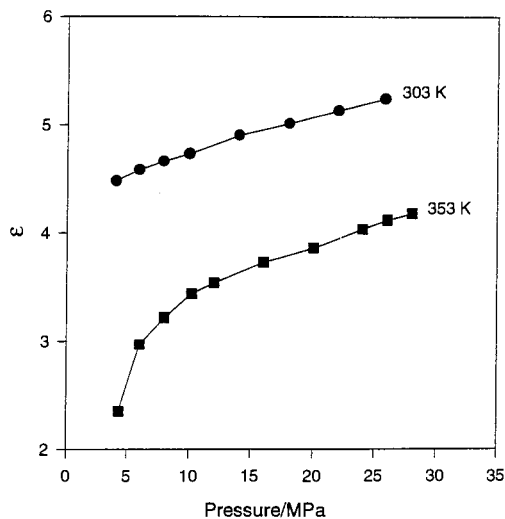

Figure 4. Pressure dependence of the relative permittivity of HFC 125 at various temperatures.

Table 2. Relative Permittivity Values for HFC 134a at 303 K

P/MPa	$\rho/\text{kg}\cdot\text{m}^{-3}$	ϵ	P/MPa	$\rho/\text{kg}\cdot\text{m}^{-3}$	ϵ
3.0	1202	9.21	20.0	1276	9.94
6.0	1218	9.39	24.0	1289	10.11
9.0	1233	9.58	28.1	1301	10.23
14.0	1254	9.78	32.7	1315	10.47

Table 3. Relative Permittivity Values for HFC 134a at 313 K

P/MPa	$\rho/\text{kg}\cdot\text{m}^{-3}$	ϵ	P/MPa	$\rho/\text{kg}\cdot\text{m}^{-3}$	ϵ
2.0	1155	8.36	12.0	1215	9.06
4.0	1169	8.52	16.0	1233	9.25
6.0	1182	8.69	34.1	1295	9.84
8.0	1194	8.87			

Table 4. Relative Permittivity Values for HFC 134a at 323 K

P/MPa	$\rho/\text{kg}\cdot\text{m}^{-3}$	ϵ	P/MPa	$\rho/\text{kg}\cdot\text{m}^{-3}$	ϵ
2.0	1110	7.73	16.0	1203	8.68
4.0	1128	7.94	20.0	1221	8.81
6.0	1144	8.0	24.1	1237	8.99
78.0	1158	8.18	28.9	1254	9.23
12.0	1182	8.45			

Table 5. Relative Permittivity Values for HFC 134a at 333 K

P/MPa	$\rho/\text{kg}\cdot\text{m}^{-3}$	ϵ	P/MPa	$\rho/\text{kg}\cdot\text{m}^{-3}$	ϵ
2.0	1058	7.15	16.0	1172	8.06
4.0	1082	7.32	19.8	1192	8.26
6.0	1103	7.48	24.0	1210	8.46
8.1	1120	7.67	26.0	1218	8.58
12.0	1148	7.88	30.0	1233	8.79

increasing pressure and decreases with increasing temperature in both liquid and supercritical phases for each solvent. Hence the isothermal density dependence of the dielectric constant $(\partial\epsilon/\partial\rho)_T$ is always positive. For all solvents ϵ increases roughly linearly with applied pressure in the liquid state. Above the critical temperature the increase in ϵ is also approximately linear with pressure at high pressures (> 20 MPa) but decreases more rapidly as the pressure approaches the critical value corresponding to the region of high fluid compressibility.

The relative permittivity data were fitted to the equation

$$\left[\frac{\epsilon - 1}{(2\epsilon + 1)} = A + B\rho_f \right]_T \quad (2)$$

Table 6. Relative Permittivity Values for HFC 134a at 343 K

<i>P</i> /MPa	$\rho/\text{kg}\cdot\text{m}^{-3}$	ϵ	<i>P</i> /MPa	$\rho/\text{kg}\cdot\text{m}^{-3}$	ϵ
4.0	1030	6.84	20.0	1162	7.85
6.0	1057	7.02	24.0	1182	7.97
8.0	1079	7.20	26.0	1190	8.02
12.0	1113	7.43	27.2	1195	8.18
15.9	1140	7.64	27.9	1199	8.13

Table 7. Relative Permittivity Values for HFC 134a at 353 K

<i>P</i> /MPa	$\rho/\text{kg}\cdot\text{m}^{-3}$	ϵ	<i>P</i> /MPa	$\rho/\text{kg}\cdot\text{m}^{-3}$	ϵ
4.0	967	6.19	18.0	1120	7.30
6.0	1005	6.4	19.9	1132	7.41
18.0	1033	6.59	22.0	1144	7.48
11.9	1075	6.86	25.9	1164	7.67
15.8	1107	7.12	28.2	1173	7.76

Table 8. Relative Permittivity Values for HFC 134a at 363 K

<i>P</i> /MPa	$\rho/\text{kg}\cdot\text{m}^{-3}$	ϵ	<i>P</i> /MPa	$\rho/\text{kg}\cdot\text{m}^{-3}$	ϵ
6.0	945	5.93	18.0	1087	6.87
10.0	1012	6.34	22.0	1114	7.16
14.0	1055	6.63	27.2	1142	7.38

Table 9. Relative Permittivity Values for HFC 134a at 373 K

<i>P</i> /MPa	$\rho/\text{kg}\cdot\text{m}^{-3}$	ϵ	<i>P</i> /MPa	$\rho/\text{kg}\cdot\text{m}^{-3}$	ϵ
4.9	822	5.25	15.8	1036	6.34
5.9	869	5.41	18.0	1054	6.53
8.0	926	5.71	22.0	1069	6.77
10.0	963	5.91	26.0	1108	6.99
11.9	992	6.09			

Table 10. Relative Permittivity Values for HFC 134a at 383 K

<i>P</i> /MPa	$\rho/\text{kg}\cdot\text{m}^{-3}$	ϵ	<i>P</i> /MPa	$\rho/\text{kg}\cdot\text{m}^{-3}$	ϵ
3.0	137	1.14	11.9	946	5.66
3.4	168	1.48	13.9	975	5.84
5.0	608	4.55	15.8	998	6.02
6.0	765	4.78	20.0	1037	6.29
7.0	822	5.05	24.0	1067	6.47
8.0	859	5.23	26.0	1080	6.57
10.0	910	5.46			

Table 11. Relative Permittivity Values for HFC 134a at 393 K

<i>P</i> /MPa	$\rho/\text{kg}\cdot\text{m}^{-3}$	ϵ	<i>P</i> /MPa	$\rho/\text{kg}\cdot\text{m}^{-3}$	ϵ
3.5	159	1.26	10.0	851	5.02
4.1	210	1.78	11.9	897	5.24
4.5	255	2.59	13.9	932	5.38
5.0	335	3.67	15.7	959	5.55
5.5	463	3.98	20.0	1003	5.90
6.0	591	4.18	24.0	1037	6.11
7.0	717	4.52	26.1	1052	6.26
8.0	779	4.75			

where ρ_r is the reduced density and *A* and *B* are constants at a given temperature. Figure 5 shows a plot of $(\epsilon - 1)/(2\epsilon + 1)$ against ρ_r for HFC 134a. Clearly $(\epsilon - 1)/(2\epsilon + 1)$ is linearly related to the isothermal reduced density. Figures 6 and 7 show that the constants of proportionality vary linearly with temperature and fit well to the equation

$$A = 0.471 - (5.1 \times 10^{-4}T) \quad (r = 0.964) \quad (3)$$

$$B = 9.5 \times 10^{-4} + (1.5 \times 10^{-4}T) \quad (r = 0.970) \quad (4)$$

where *T* is the temperature in K. The equation also holds for HFC 32 and HFC 125, with the appropriate constants given in Table 17.

Table 12. Relative Permittivity Values for HFC 134a at 403 K

<i>P</i> /MPa	$\rho/\text{kg}\cdot\text{m}^{-3}$	ϵ	<i>P</i> /MPa	$\rho/\text{kg}\cdot\text{m}^{-3}$	ϵ
3.4	141	1.09	12.9	867	4.93
5.0	270	2.32	13.9	886	5.06
7.0	583	3.84	15.6	919	5.24
8.0	682	4.19	18.0	946	5.42
9.0	743	4.35	22.0	989	5.68
10.0	785	4.60	26.1	1022	5.94
11.9	844	4.81			

Table 13. Relative Permittivity Values for HFC 32 at 303 K

<i>P</i> /MPa	$\rho/\text{kg}\cdot\text{m}^{-3}$	ϵ	<i>P</i> /MPa	$\rho/\text{kg}\cdot\text{m}^{-3}$	ϵ
4.0	955	12.51	20.0	1029	13.92
5.9	967	12.79	24.0	1042	14.20
8.0	978	12.97	26.0	1048	14.29
12.0	997	13.35	26.9	1050	14.40
16.0	1014	13.67			

Table 14. Relative Permittivity Values for HFC 32 at 363 K

<i>P</i> /MPa	$\rho/\text{kg}\cdot\text{m}^{-3}$	ϵ	<i>P</i> /MPa	$\rho/\text{kg}\cdot\text{m}^{-3}$	ϵ
4.9	132	1.54	12.0	725	7.80
5.5	164	2.02	16.0	786	8.46
6.0	200	3.09	20.1	826	8.99
7.0	347	5.78	24.0	857	9.36
8.1	564	6.71	26.1	870	9.59
9.0	632	7.10	28.1	882	9.72
10.0	674	7.39			

Table 15. Relative Permittivity Values for HFC 125 at 303 K

<i>P</i> /MPa	$\rho/\text{kg}\cdot\text{m}^{-3}$	ϵ	<i>P</i> /MPa	$\rho/\text{kg}\cdot\text{m}^{-3}$	ϵ
4.0	1197	4.48	14.0	1288	4.90
5.9	1221	4.58	18.0	1313	5.01
7.9	1241	4.66	22.0	1334	5.13
10.0	1259	4.73	25.8	1353	5.24

Table 16. Relative Permittivity Values for HFC 125 at 353 K

<i>P</i> /MPa	$\rho/\text{kg}\cdot\text{m}^{-3}$	ϵ	<i>P</i> /MPa	$\rho/\text{kg}\cdot\text{m}^{-3}$	ϵ
6.0	828	2.97	20.0	1145	3.86
8.0	941	3.22	24.0	1180	4.03
10.2	1000	3.44	26.0	1195	4.11
12.0	1042	3.54	28.0	1209	4.17
16.0	1102	3.73			

Table 17. *A* and *B* Values for HFC 32 and HFC 125, Where *T* Is the Temperature in K

	HFC 32	HFC 125
<i>A</i>	$0.541 - (5.6 \times 10^{-4}T)$	$0.392 - (6.5 \times 10^{-4}T)$
<i>B</i>	$2.0 \times 10^{-4}T - 0.0303$	$0.0151 + (1.9 \times 10^{-4}T)$

Kirkwood's theory of molecular polarizability (Kirkwood, 1939), employing the definition of the Onsager local field in a liquid assembly of permanent dipoles (Onsager, 1936), is assumed the most appropriate for the three HFCs studied. The relative permittivity of a polar liquid can be related to the apparent dipole moment μ^* through the equation

$$\frac{(\epsilon - 1)(2\epsilon + 1)}{9\epsilon} \left(\frac{M}{\rho} \right) = \frac{N_0}{3} \left(\alpha + \frac{\mu^{*2}}{3\epsilon_0 k_B T} \right) \quad (5)$$

where *M* is the relative molecular mass, N_0 the Avogadro number, ϵ_0 the vacuum permittivity, α the molecular polarizability of the molecule, and k_B the Boltzmann constant.

By performing a linear regression of the Kirkwood function as a function of $1/T$, the value of μ^* can be

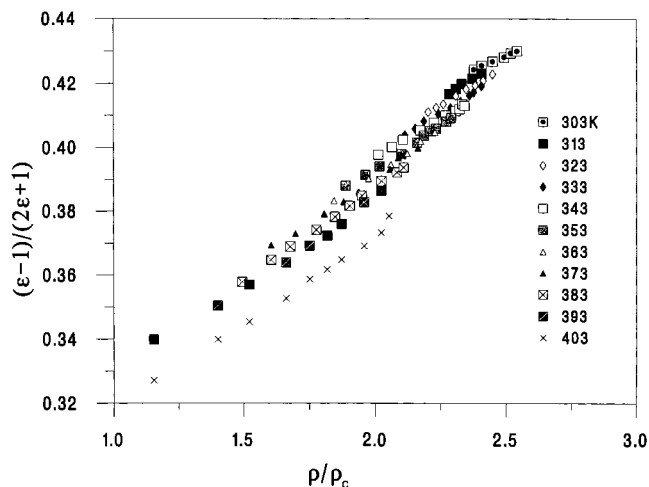

Figure 5. $(\epsilon - 1)/(2\epsilon + 1)$ as a function of reduced density (ρ/ρ_c) for HFC 134a.

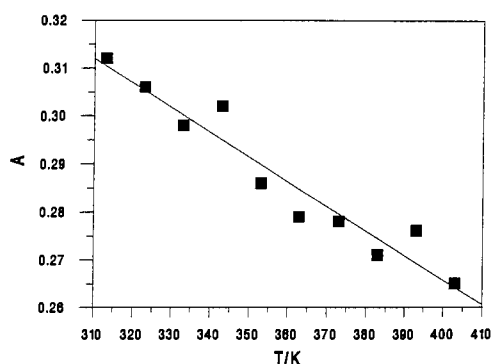

Figure 6. A as a function of temperature for HFC 134a.

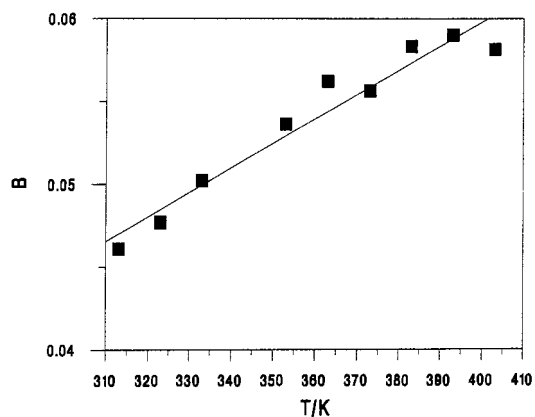

Figure 7. B as a function of temperature for HFC 134a.

determined. For each temperature the Kirkwood function was approximately independent of density. In Figure 8 the mean Kirkwood function at each temperature is plotted against $1/T$ for HFC 134a, yielding a dipole moment in the liquid phase of $\mu^* = (3.20 \text{ D} \pm 0.36)$ ($r = 0.997$). The large uncertainty is a consequence of the error associated with

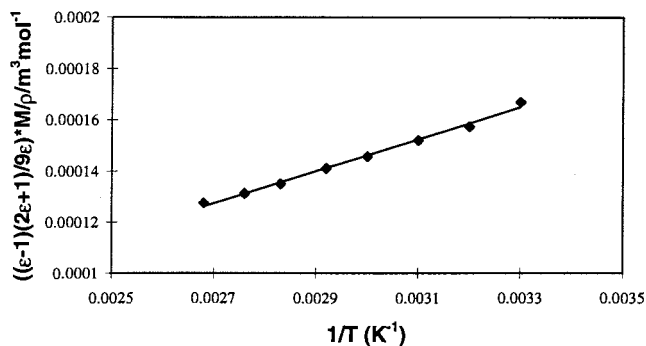

Figure 8. Determination of the dipole moment of HFC 134a in the liquid phase by the Kirkwood representation.

each density calculation. This measurement agrees with the previously obtained value of $\mu^* = (3.54 \text{ D} \pm 0.01)$ (Barao et al., 1995) within experimental uncertainties.

Conclusion

The relative permittivity of environmentally acceptable refrigerants HFC 134a, HFC 32, and HFC 125 has been measured at temperatures ranging from 303 to 403 K under pressures from 4.0 to 30.0 MPa. Under these conditions the isothermal pressure dependence of the relative permittivity $(\delta\epsilon/\delta P)_T$ is always positive, and the isobaric temperature dependence $(\delta\epsilon/\delta T)_P$ always negative in both the liquid and supercritical phases. The relative permittivity has been fitted to the reduced density employing the function $(\epsilon - 1)/(2\epsilon + 1)$ and the dipole moment of HFC 134a in the liquid phase reported.

Literature Cited

- Abbott, A. P.; Eardley, C. A. Solvent Properties of Liquid and Supercritical 1,1,1,2-Tetrafluoroethane (HFC 134a). *J. Phys. Chem. B* **1998**, *102*, 8574–8578.
- Barao, T.; Nieto de Castro, C. A.; Mardolcar, U. V.; Okambawa, R.; St-Arnaud, J. M. Dielectric Constant, Dielectric Virial Coefficients, and Dipole Moments of 1,1,1,2-Tetrafluoroethane. *J. Chem. Eng. Data* **1995**, *40*, 1242–1248.
- Kirkwood, J. G. The Dielectric Polarization of Polar Liquids. *J. Chem. Phys.* **1939**, *7*, 911–919.
- Meyer, C. W.; Morrison, G. Dipole Moments of Seven Partially Halogenated Ethane Refrigerants. *J. Phys. Chem.* **1991**, *95*, 3860–3866.
- Meyer, C. W.; Morrison, G. Dipole Moments of Seven Refrigerants. *J. Chem. Eng. Data* **1991**, *36*, 409–413.
- Onsager, L. Electric Moments of Molecules in Liquids. *J. Am. Chem. Soc.* **1936**, *58*, 1486–1493.
- Outcalt, S. L.; McLinden, M. O. Equation of State for the Thermodynamic Properties of R32 (Difluoromethane) and R125 (Pentafluoroethane). *Int. J. Thermophys.* **1995**, *16*, 79–89.
- Tillner-Roth, R.; Baehr, H. D. An International Standard Formulation for the Thermodynamic Properties of 1,1,1,2-Tetrafluoroethane (HFC-134a) for Temperatures from 170 K to 455 K and Pressures up to 70 MPa. *J. Phys. Chem. Ref. Data* **1994**, *23*, 657–729.
- Tillner-Roth, R.; Yokozeki, A. An International Standard Equation of State for Difluoromethane (R-32) for Temperatures from the Triple Point at 136.34 K to 435 K and Pressures up to 70 MPa. *J. Phys. Chem. Ref. Data* **1997**, *26*, 1273–1328.

Received for review June 4, 1998. Accepted October 9, 1998.

JE980130B